

REV	DESCRIPTION	BY	DATE

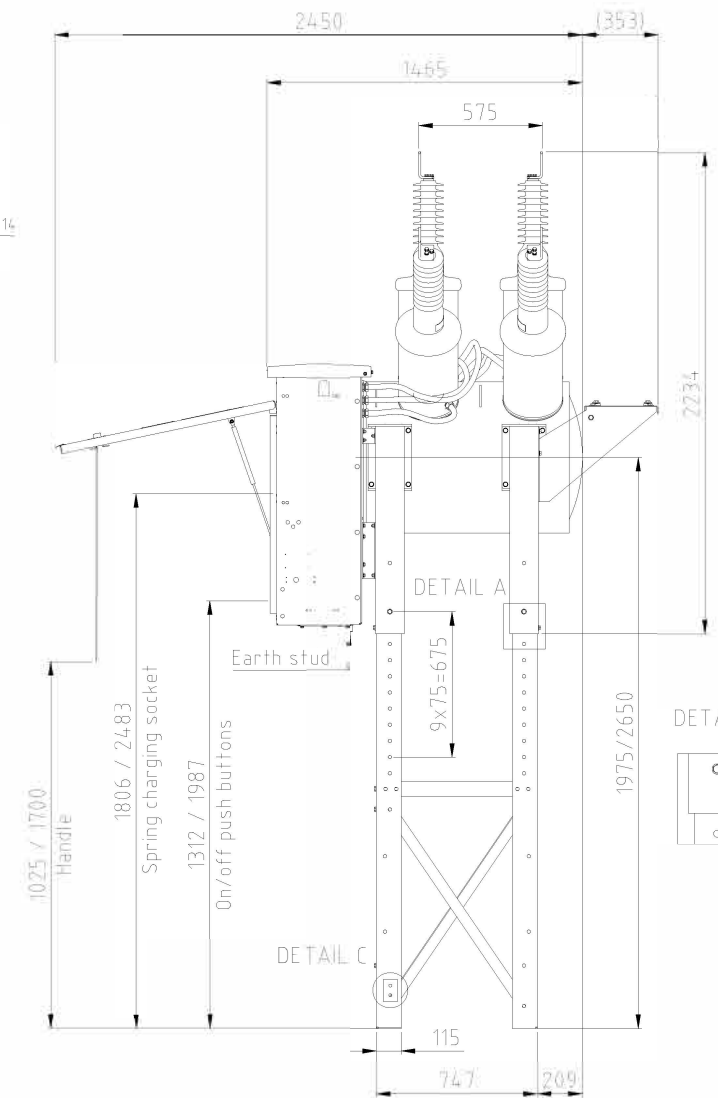

SIDE VIEW AT MAXIMUM HEIGHT
(DIMENSIONS GIVEN FOR SUPPORT AT MIN/MAX HEIGHT)

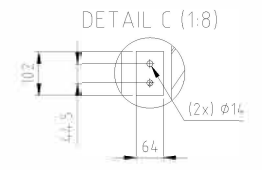
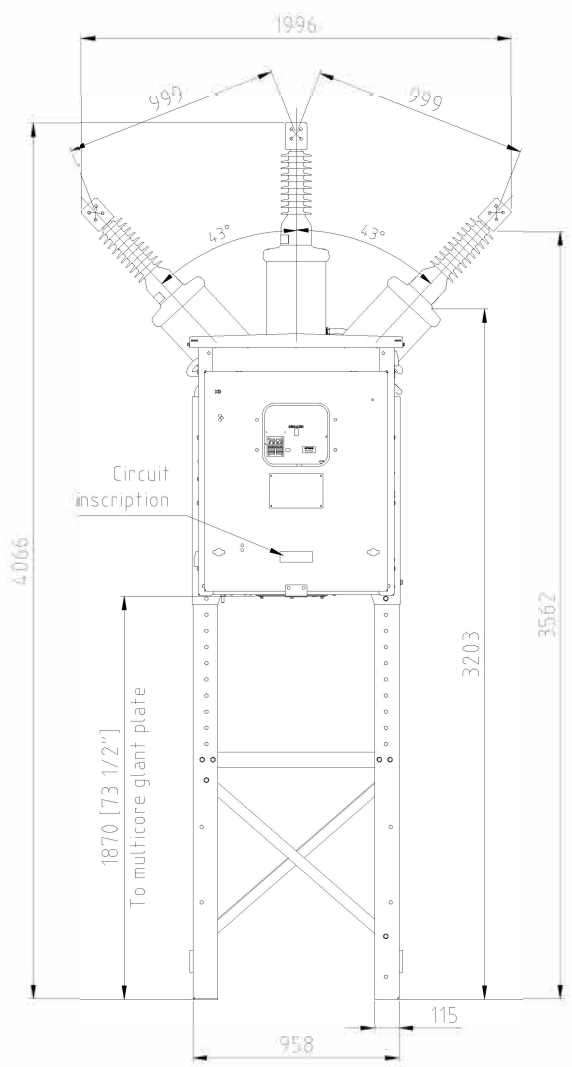

FRONT VIEW
SUPPORT AT MAXIMUM HEIGHT

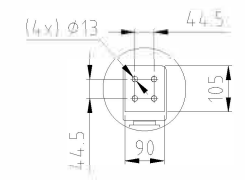

DETAIL B (1:8)

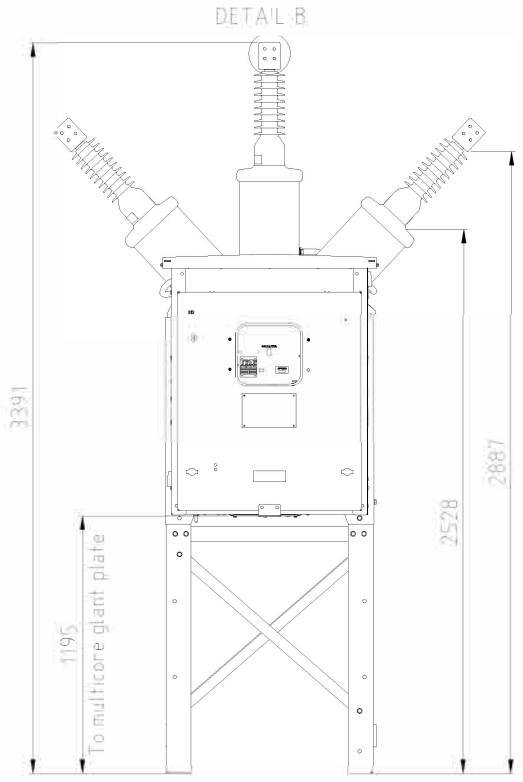

FRONT VIEW
SUPPORT AT MINIMUM HEIGHT

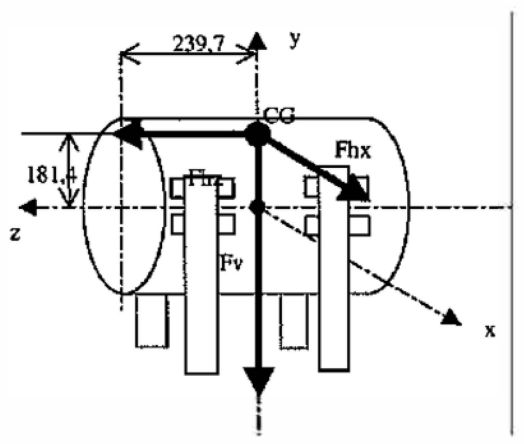
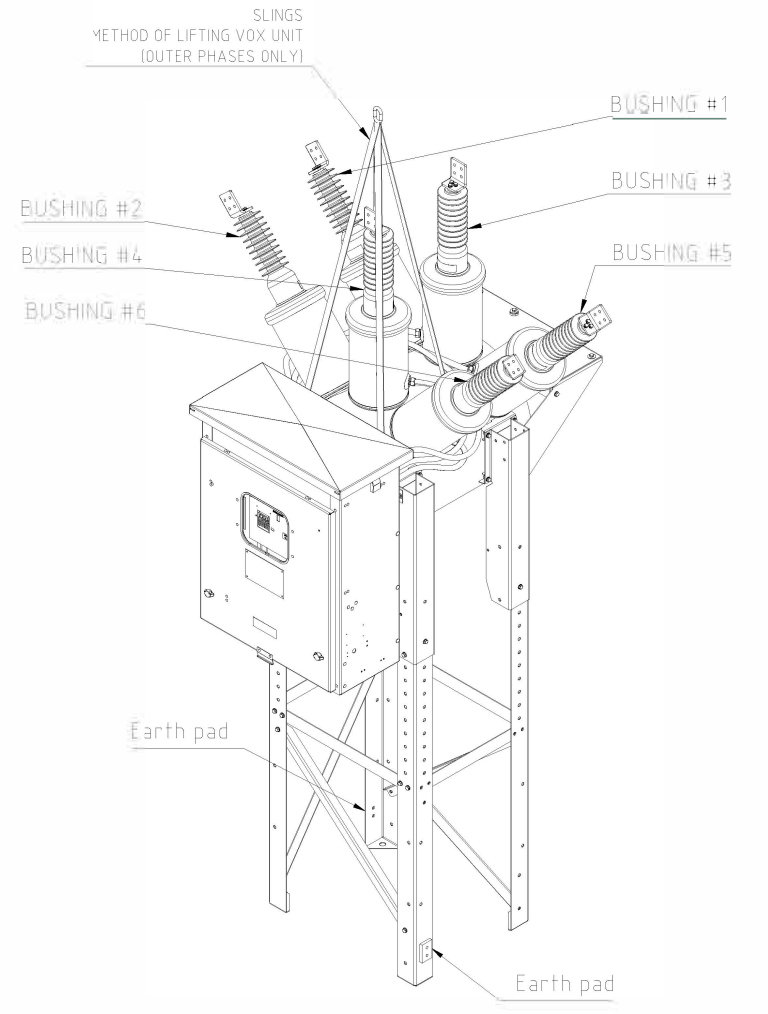

CENTER OF GRAVITY

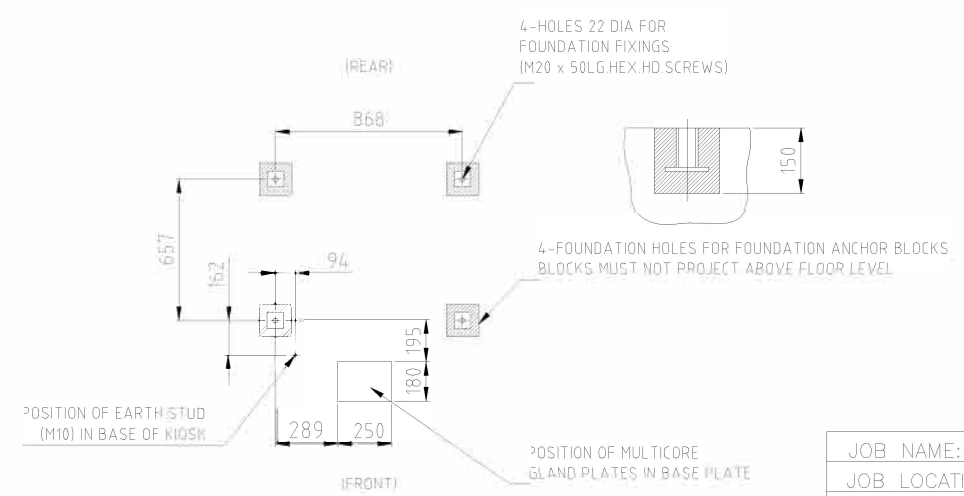

FOUNDATION PLAN
TOP VIEW

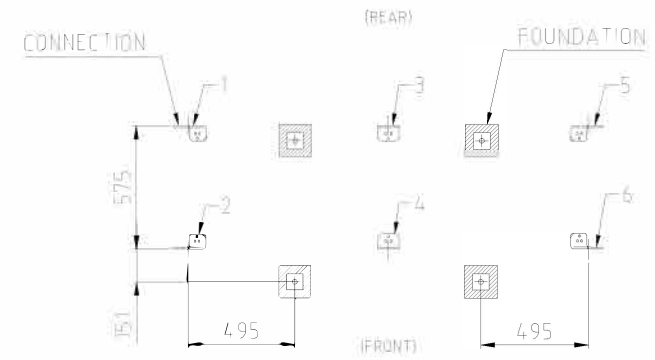

POSITION FOUNDATION / CONNECTION
TOP VIEW

NOTE 1: MINIMUM DISTANCE BETWEEN THE VOX LIVE PARTS AND THE OTHERS DEVICES IS 1200 mm.
NOTE 2: ALL DIMENSIONS IN MILLIMETER

JOB NAME:	27.5KV BREAKER	EQUIPMENT DESIGNATION:	STATION BREAKER - VOX
JOB LOCATION:		EQUIPMENT TYPE:	STATION BREAKER - VOX
DRAWN BY:		DRAWING TYPE:	GENERAL ARRANGEMENT
VERIFIED BY:			
DATE:	JUNE 4, 2018		
DRAWING STATUS:	FOR QUOTE ONLY		
DWG#		PG	1 OF 1

REV	DESCRIPTION	BY	DATE																
---	---	---	---	---	---	---	---	---	---	---	---	---	---	---	---	---	---	---	---

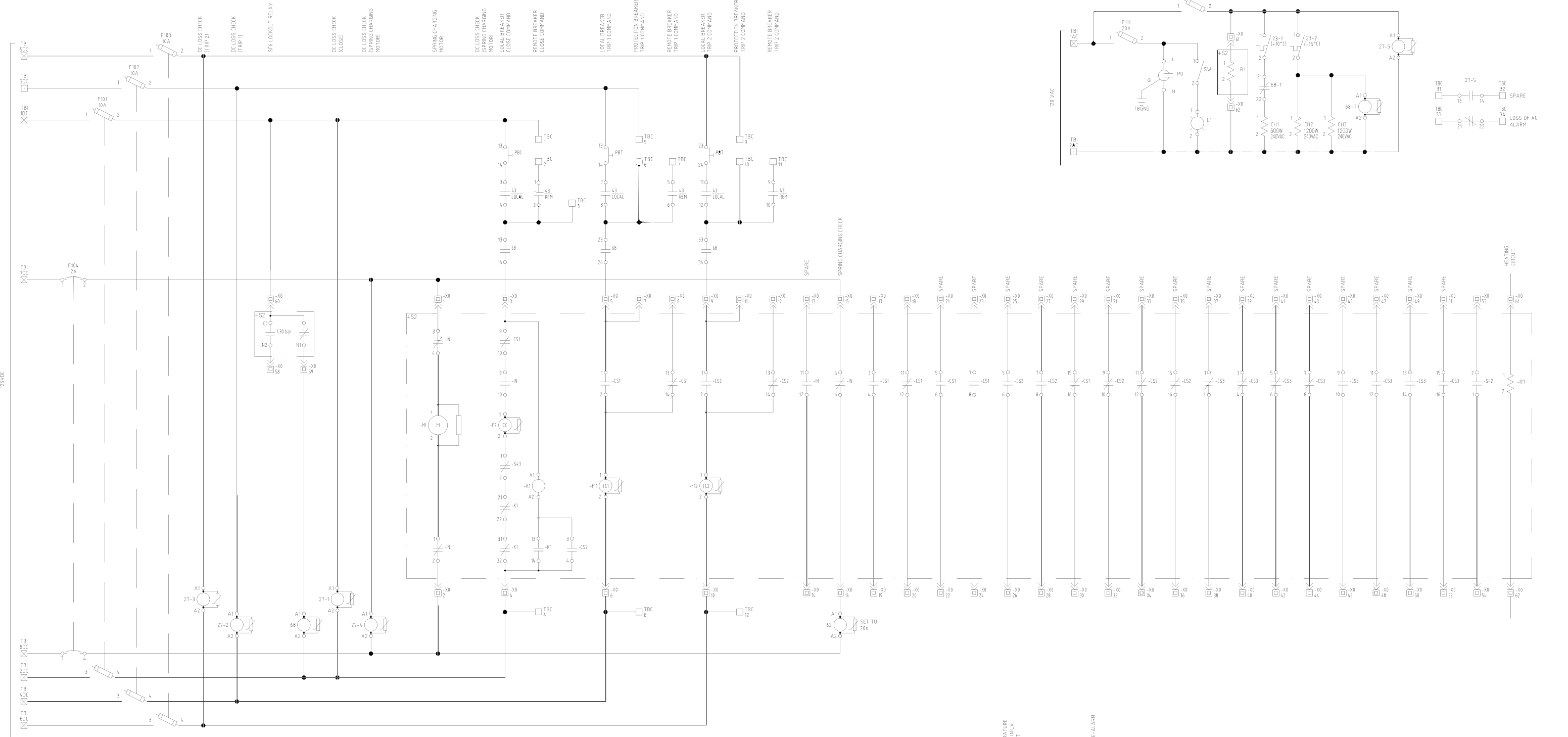

43 CONTACTS				LOCAL	OFF	REMOTE
1	2	3	4	1		X
5	6	7	8	2	X	
9	10	11	12	3		X
13	14	15	16	4	X	
				5		X
				6	X	
				7		X
				8	X	

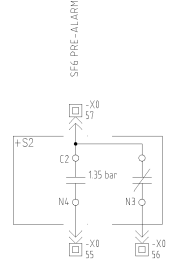
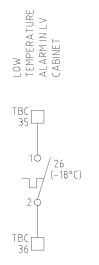
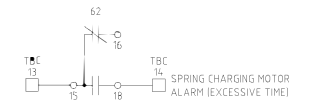
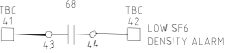
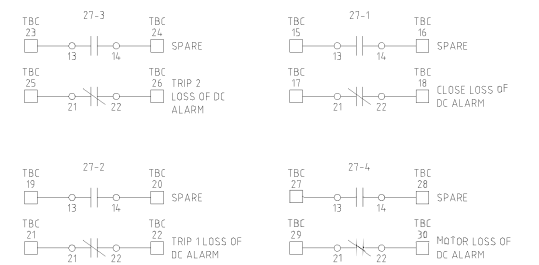

NOTE
 SCHEMATIC IS SHOWN:
 - CIRCUIT BREAKER SPRING DISCHARGED
 - WITHOUT DC/AC POWER SUPPLY
 - ALL FUSE HOLDERS/MINI CIRCUIT BREAKERS OPEN
 - BREAKER MECHANICAL PUSH BUTTONS NOT PRESSED
 - WITH SF6 GAS
 - AMBIENT TEMPERATURE >15°C

NOTE
 ALL CONTROL WIRES SIZE SHALL BE TYPE "SIS" #14 AWG.
 ALL CURRENT WIRES SIZE SHALL BE TYPE "SIS" #10 AWG.
 ALL GROUND WIRES SIZE SHALL BE TYPE "SIS" GREEN #12 AWG.
 ALL WIRE COLORS ARE GRAY UNLESS OTHERWISE NOTED.
 LEGEND SEE DRAWING C40432583-001-#1-1

JOB NAME:	27.5KV BREAKER	EQUIPMENT DESIGNATION:	STATION BREAKER - VOX
JOB LOCATION:		EQUIPMENT TYPE:	STATION BREAKER - VOX
DRAWN BY:		DRAWING TYPE:	CONTROL SCHEMATIC
VERIFIED BY:			
DATE:	June 4, 2018		
DRAWING STATUS:	FOR QUOTE ONLY	DWG#	





REV	DESCRIPTION	BY	DATE								
-	-----	--	--/--/--	-	-----	--	--/--/--	-	-----	--	--/--/--





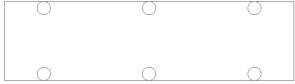
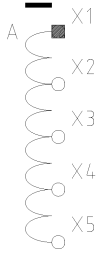

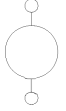

CIRCUIT BREAKER DEVICE LEGEND

- F11 : 1ST SHUNT TRIP COIL
- F12 : 2ND SHUNT TRIP COIL
- F2 : SHUNT CLOSING COIL
- M1 : SPRING CHARGING MOTOR
- K1 : ANTI PUMPING RELAY
- IN : SPRING OPERATED LIMIT SWITCH
- CS1, -CS2, -CS3 : MECHANICALLY OPERATED CONTACT (MOC)
- S42 : CONTACT (NO) OPERATED BY THE BREAKER CLOSE MECHANICAL PUSH BUTTON
- S43 : CONTACT (NC) OPERATED BY THE BREAKER TRIP MECHANICAL PUSH BUTTON
- R1 : ANTI-CONDENSATION HEATER IN THE CB MECHANISM

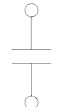
THREE LINE DIAGRAM DEVICE LEGEND

-  : CIRCUIT BREAKER
-  : MULTI RATIO CURRENT TRANSFORMER
-  : CT CONNECTIONS TERMINAL BLOCK
-  : GROUND

DC CONTROL DIAGRAM DEVICE LEGEND

-  : RELAY OR CONTACTOR
-  : NORMALLY CLOSED CONTACT
-  : NORMALLY OPEN CONTACT
-  : MINIATURE CIRCUIT BREAKER
-  : CUSTOMER TERMINAL BLOCK
-  : DRIVE MECHANISM TERMINAL BLOCK PHEONIX CONTACT
-  : PUSH-BUTTON
-  : SPACE HEATER
- 43 : LOCAL/REMOTE SELECTOR SWITCH
- 68-T : 2ND STAGE HEATING LOCKOUT
- PO : POWER OUTLET
- 23-1 : 1ST STAGE HEATING THERMOSTAT
- 23-2 : 2ND STAGE HEATING THERMOSTAT
- 26 : ALARM THERMOSTAT
- SW : INTERRUPTER SWITCH
- PBC : PUSH BUTTON CLOSE
- PBT : PUSH BUTTON TRIP

JOB NAME:	27.5KV BREAKER	EQUIPMENT DESIGNATION:	STATION BREAKER - VOX	
JOB LOCATION:		EQUIPMENT TYPE:	STATION BREAKER - VOX	
DRAWN BY:		DRAWING TYPE:	LEGEND / INFORMATION	
VERIFIED BY:				
DATE:	JUNE 4, 2018			
DRAWING STATUS:	FOR QUOTE ONLY			
DWG#		PG 1	OF 1	REV -

REV	DESCRIPTION	BY	DATE						
-	----	--	--/--	-	----	--	--/--	-	----

LEFT PANEL

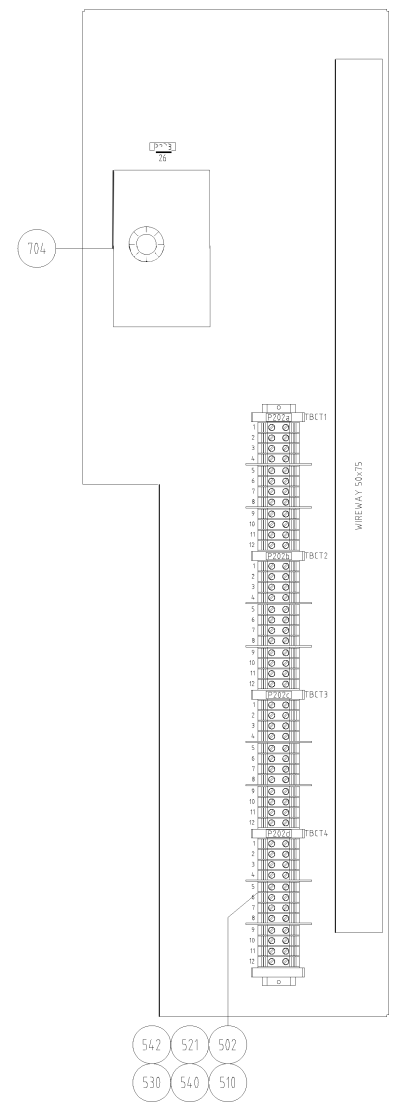

REAR PANEL

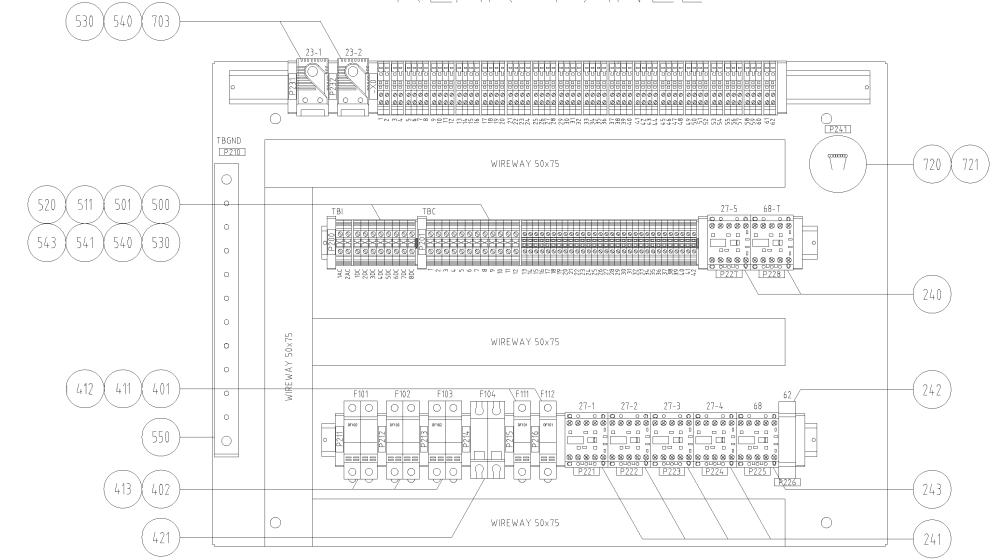

RIGHT PANEL

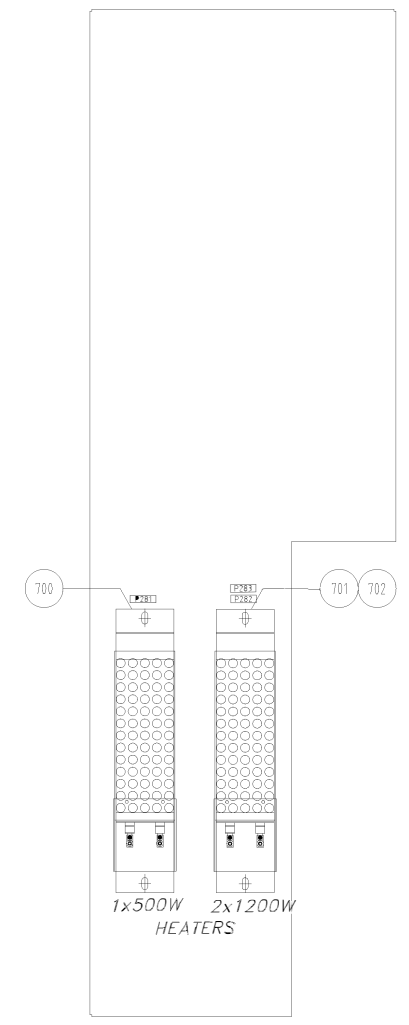

ROTATING PANEL (REAR VIEW)

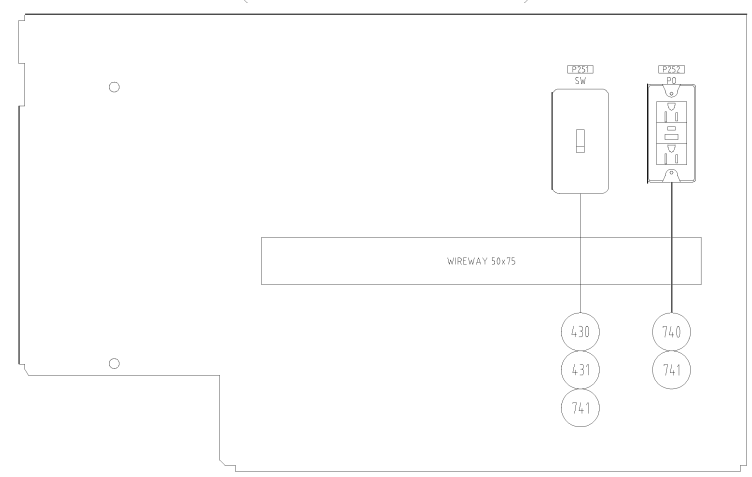

(FRONT VIEW)

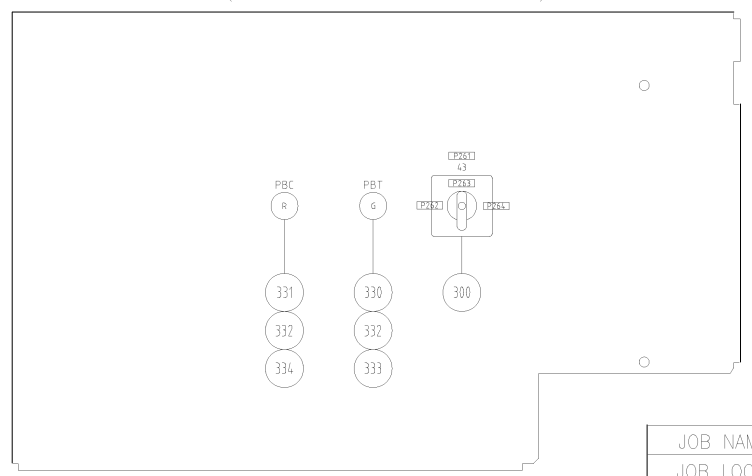

- 600 601 602 603 WIRES
- 607 606 605 604
- 570 560 WIRING DUCTS
- 590 MOUNTING RAILS
- 620 621 622 623 WIRE LUGS

It.	Qty	Part No.	Reference
741	2	CNGAC0001	RECT. ELEC. BOX WESTINGHOUSE 2020
740	1	SE6000206	POWER OUTLET GFCI 15A HUBBELL GF5262A
721	1	SE4000213	PORC. BULB SOCKET LEVITON 9880
720	1	LEDA155W27K120V	LED LIGHT BULB 120V 5W
704	1	ES04322	CAPILLARY THERMOSTAT CALORITECH AR0464
703	2	ES07143	ADJUST. THERMOSTAT STEGO 01157.0-00
702	1	46028-127-02	HEATER 1200W/24.0V HEATREX HX-565073
701	1	46028-127-01	HEATER 1200W/24.0V HEATREX HX-565072
700	1	46028-126-01	HEATER 500W/24.0V HEATREX HX-565074
623	1	301-065	RING TERM 2-1AWG T&B G973
622	1	301-063	RING TERM 2-1AWG T&B G971
621	2	531634	TERM LUG 6AWG PANDUIT P6-14.4-T
620	100	CNSED10	RING TERMINAL 10-12AWG T&B RC637
607	25	ES01398	WIRE SIS 12 AWG GRAY
606	5	SE3000114	WIRE 6 AWG TEW 7 STRANDS
605	5	SE3000191	WIRE 2 AWG COPPER
604	5	ES07413	WIRE SIS 10 AWG GREEN
603	10	ES06057	WIRE SIS 12 AWG GREEN
602	10	ES02254	WIRE 14 AWG SEW2
601	5	281-039	WIRE SIS 10 AWG GRAY
600	200	281-040	WIRE SIS 14 AWG GRAY
590	10	BNAC0003-2	RAIL SYM 35MM ENTRELEC 173 220 05
570	33	282-003	WIRING DUCT COVER 2" GRAY PANDUIT C2L66
560	10	282-016	WIRING DUCT GRAY 2"X3" PANDUIT G2X3L66
550	1	MVCD00092-00	GROUND BAR
543	6	ES07392-6	UNPRINTED MARKERS Z86 PHOENIX CONTACT 5060935
542	10	ES07392-10	BLANK MARKERS Z810 PHOENIX CONTACT 1053004
541	5	ES07392-8	UNPRINTED MARKERS Z88 PHOENIX CONTACT 5060896
540	14	ES07394	MARKER KLM PHOENIX CONTACT 1004306
530	19	ES07393	END STOP CLIPFIX 35 PHOENIX CONTACT 3022218
521	4	ES07396-6	END PLATE D-OTTA 6 PHOENIX CONTACT 0790417
520	2	ES07390	END PL D-UT 2.5/10 PHOENIX CONTACT 3047028
511	2	ES07391	PARTITION PLATE ATP-UTP PHOENIX CONTACT 3047167
510	8	ES07397-6	PART. PLATE ATP-OTTA 6 PHOENIX CONTACT 0790475
502	48	ES07395-6	TERM. BLK OTTA 6 PHOENIX CONTACT 0790433
501	22	ES07389-6	TERM. BLK UT 6 PHOENIX CONTACT 3044131
500	30	ES07389-4	TERM. BLK UT 4 PHOENIX CONTACT 3044102
431	1	331-008	SWITCH COVER TEMCO 20C-5
430	1	331-019	LIGHT SWITCH LEVITON 1101-CB
421	1	60137	MINI BREAKER 2P 2A SE 60137
413	6	ES07211-10	FUSE 10A COOPER BUSSMANN KTK-10
412	1	ES07211-15	FUSE 15A COOPER BUSSMANN KTK-15
411	1	ES07211-20	FUSE 20A COOPER BUSSMANN KTK-20
402	3	DF102	FUSE HOLDER 2P SE DF102
401	2	DF101	FUSE HOLDER 1P SE DF101
334	1	ES07246	NP PUSHBUTTON CLOSE SE ZBY2314
333	1	ES07245	NP PUSHBUTTON OPEN SE ZBY2313
332	2	ES07045	CONTACT BLOCK 2 NO SE ZB4B2103
331	1	ES07043	PUSHBUTTON BODY RED SE ZB4BL4
330	1	ES07042	PUSHBUTTON BODY GREEN SE ZB4BL3
300	1	K1H004UCH	SELECTOR SW 3POS 1P SE K1H004UCH
243	1	ES06905	AUX. RELAY SE CA3KN40GD3
242	1	RE17RMW	AUX. TIMING RELAY SE RE17RMW
241	4	ES05664	AUX. RELAY SE CA3KN22GD3
240	2	ES07311	AUX. RELAY SE CA2KN22GT2

JOB NAME:	27.5KV BREAKER	EQUIPMENT DESIGNATION:	STATION BREAKER - VOX
JOB LOCATION:		EQUIPMENT TYPE:	STATION BREAKER - VOX
DRAWN BY:		DRAWING TYPE:	DOOR DETAIL VIEWS
ENGR:			
DATE:	JUNE 4, 2018		
DRAWING STATUS:	FOR QUOTE ONLY	DWG#	PG 1 OF 1 REV -



REV	DESCRIPTION	BY	DATE								
-	----	--	--/--/--	-	----						

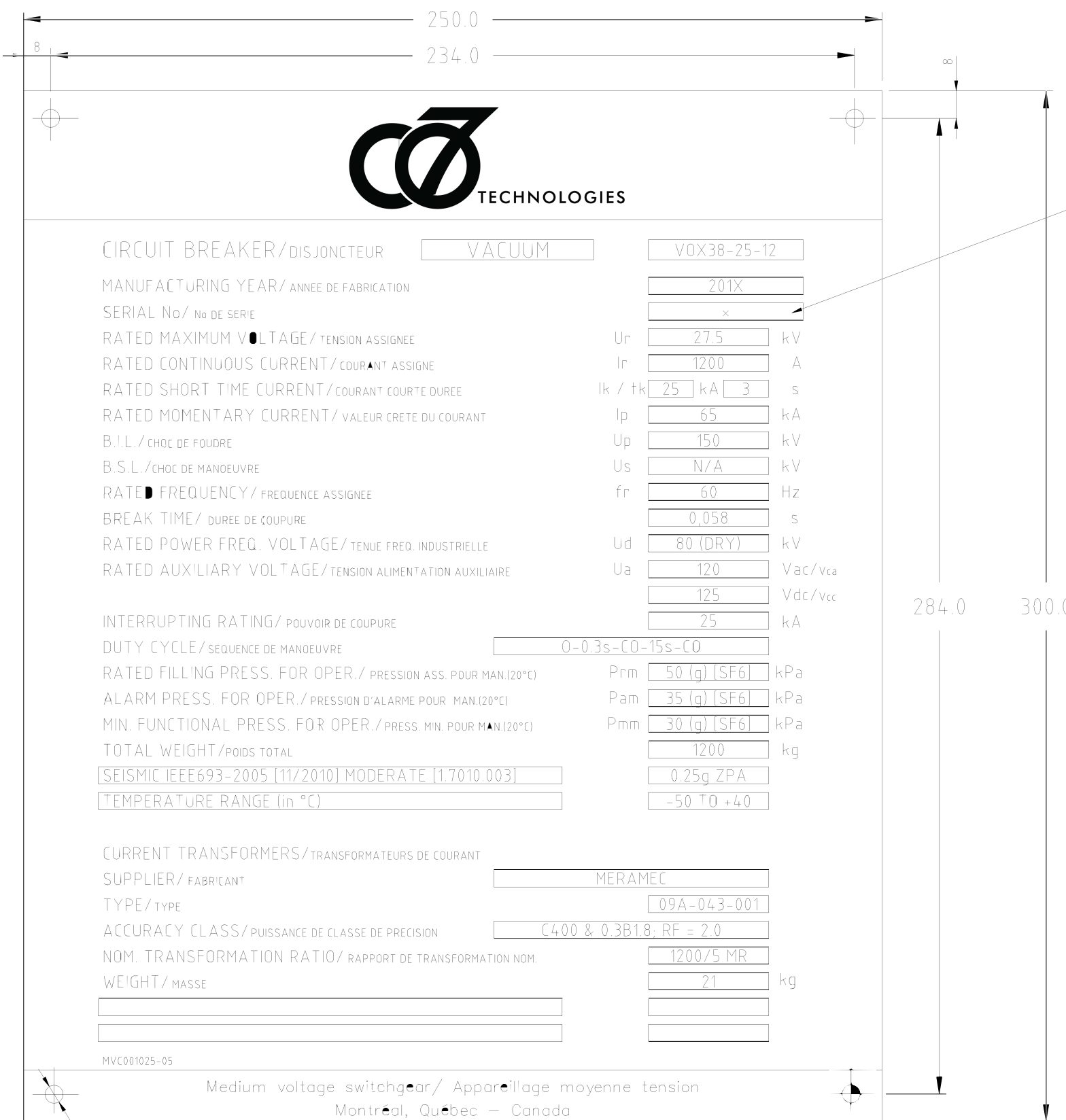

SEE SERIAL NUMBER TABLE

NOTES:

- Material: anodized aluminium 0.060". The shaded spaces, the text and also the lines are black on aluminium background
- SCHNEIDER logo green

4 HOLES Ø5,2

Medium voltage switchgear/ Appareillage moyenne tension
Montréal, Québec - Canada

JOB NAME:	27.5KV BREAKER	EQUIPMENT DESIGNATION:	STATION BREAKER - VOX
JOB LOCATION:		EQUIPMENT TYPE:	STATION BREAKER - VOX
DRAWN BY:		DRAWING TYPE:	NAMEPLATE
VERIFIED BY:			
DATE:	JUNE 4, 2018		
DRAWING STATUS:	FOR QUOTE ONLY	DWG#	

